

Article number: 0107042

Description: Retaining ring AK 25 DIN 983

Measures

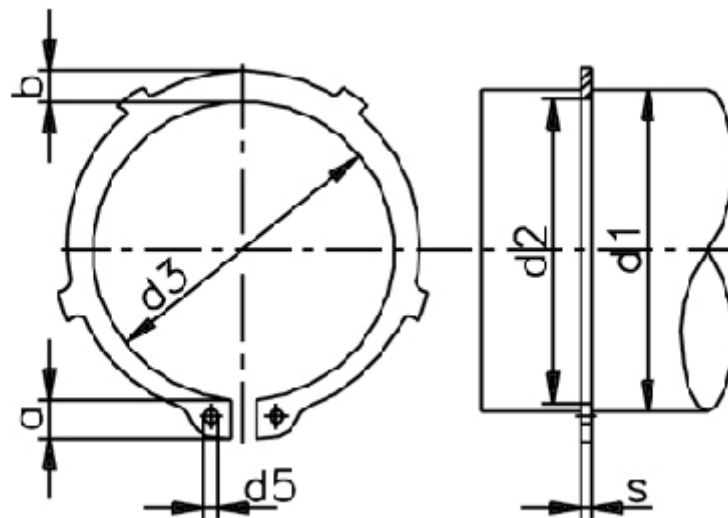

a max	= 4.3	FN kN	= 7.05	Number of serrations	= 6
AN mm ²	= 42.3	FRg kN	= 3.7	s	= 1.20
b	= 3.0	FR kN	= 16.2	t	= 0.55
d1	= 25	g	= 1.5	tol	= -0.21
d2	= 23.9	K kN-mm	= 33.4	tol	= -0.06
d3	= 23.2	m min	= 1.30	tol	= +0,21-0,42
d5 min	= 2.0	n abl x 1000	= 24	Tong	= ZGA-2
Description	= AK 25	Nominal drive	= 1.6	Weight kg/1000	= 2.12